



Centrifuge 5415 D and Centrifuge 5415 R











Instruction Manual · Mode d'emploi succinct
Instrucciones resumidas

eppendorf

Centrifuge 5415 D / R

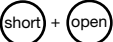
| | |
|--|----|
| Instruction Manual | 5 |
| Mode d'emploi succinct 5415 D / R | 22 |
| Instrucciones resumidas 5415 D / R | 27 |

Shortcuts

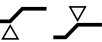
| Task | Lid | Press | Display 5415 R | Instruction manual |
|--|---|--|---|--------------------|
| Parameter change during centrifugation |  closed |  > 2 sec | Display flashes 5 sec | 3.4 |
| Signal ON / OFF |  open |  > 2 sec |  | 3.11 |
| Parameter lock ON / OFF |  open |  > 2 sec |  | 3.5 |
| At set rpm |  open |  > 2 sec |  | 3.6 |

No part of this publication may be reproduced without the prior permission of the copyright owner.

Copyright© 2003 Eppendorf AG, Hamburg

Centrifuge 5415 D

Figur 1

Figur 1



Centrifuge 5415 R

Figur 2

Figur 2

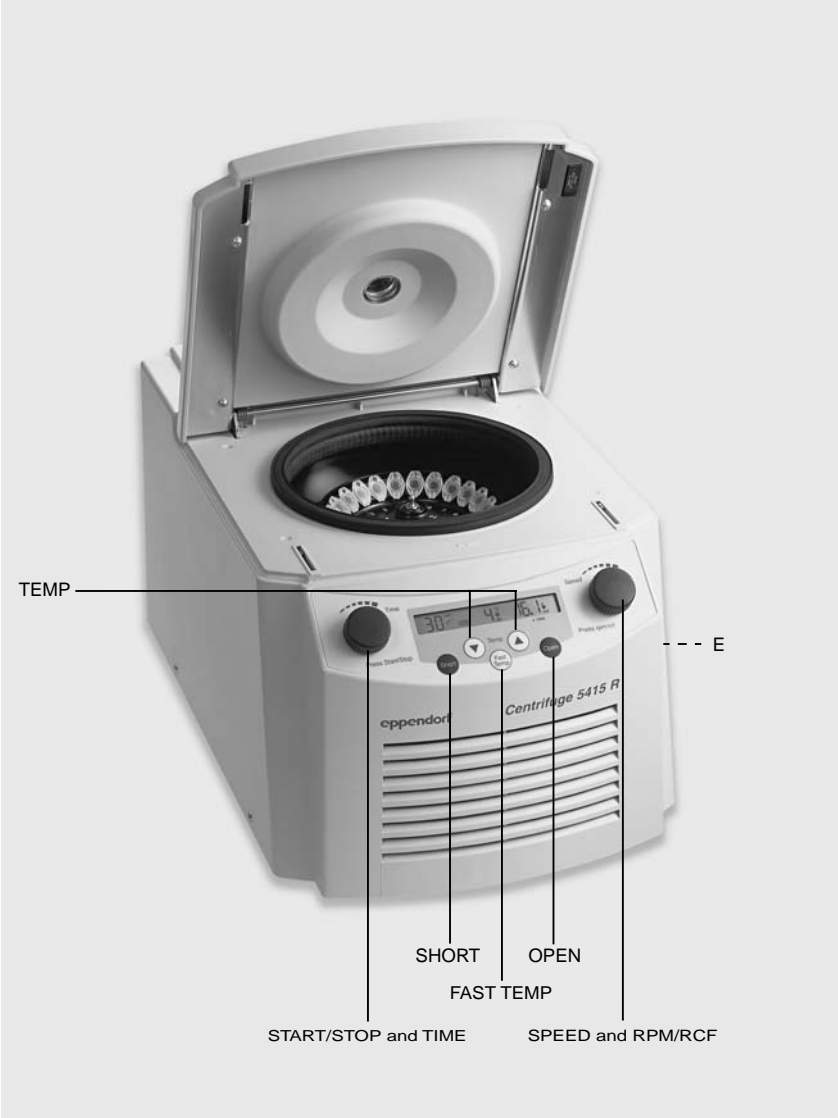

| | | |
|----------|--|-----------|
| 1 | Introduction | 6 |
| 2 | Safety precautions and applicational limitations. | 8 |
| 3 | Operation | 10 |
| 3.1 | Control elements | 10 |
| 3.2 | Loading the rotor | 10 |
| 3.3 | Centrifugation with time setting | 11 |
| 3.4 | Changing the centrifugations parameters during the run. | 11 |
| 3.5 | Fixed setting of the parameters (only for 5415 R) | 11 |
| 3.6 | Centrifugation with "AT set rpm" (for 5415 R only). | 12 |
| 3.7 | Short-spin centrifugation | 12 |
| 3.8 | Continuous centrifugation | 12 |
| 3.9 | Switching to the rcf display | 12 |
| 3.10 | Cooling (for 5415 R only) | 12 |
| 3.11 | Switching the signal tone on and off (only for 5415 R). | 13 |
| 3.12 | Opening the centrifuge in the case of a power failure | 13 |
| 3.13 | Device fuses | 13 |
| 4 | Cleaning and maintenance | 14 |
| 4.1 | Device | 14 |
| 4.2 | Rotors | 14 |
| 4.3 | Aerosol-tight rotors | 14 |
| 4.4 | Rotor sterilization | 14 |
| 4.5 | Glass breakage | 14 |
| 4.6 | Return of the device | 15 |
| 5 | Troubleshooting | 16 |
| 6 | Technical data | 18 |
| 7 | Ordering information | 20 |

1 Introduction

The Centrifuge 5415 D is a non-refrigerated bench-top centrifuge and the Centrifuge 5415 R is a refrigerated bench-top centrifuge. Both are used in research and routine laboratories in the biosciences, industry, clinics and chemistry.

With their space-saving design and user-friendly operating concept, these centrifuges are ideal for everyday routine tasks.

In both devices 24 or 36 Eppendorf micro test tubes can be centrifuged simultaneously in a 45° fixed-angle rotor at 16,100 rcf (13,200 rpm).

The basic functions can be selected using the "SHORT" key and the "TIME" and "SPEED" dial. The values appear in the display in digital form.

Before starting up Centrifuges 5415 D / R for the first time, please read the instruction manual. The latest version of the manual and the safety instructions in your language can be found on the Internet at www.eppendorf.com.



This sign is found on your centrifuge and on several pages in the operating manual. Texts labeled with this sign contain safety notes. Read these safety precautions before using the centrifuge for the first time.

1.1 Delivery package

| | | |
|----------------------------------|-----------------------|------|
| 1 Centrifuge 5415 R (w/o rotor) | Order No. 22 62 140-8 | or |
| 1 Centrifuge 5415 D (with rotor) | Order No. 22 62 120-3 | or |
| 1 Centrifuge 5415 D (w/o rotor) | Order No. 22 62 121-1 | with |
| 1 Main power cable | | |
| 1 Instruction manual | | |
| 1 Rotor key | | |
| 1 Set of fuses | | |

1.2 Setting up the device



Place the centrifuge onto a stable, horizontal work surface. Ensure that the working environment is well ventilated! According to the requirements of the EN 61010-2-020 standard, a safety distance of 30 cm must be observed around the centrifuge during operation. No objects whose destruction may cause damage should be positioned in this space.

Please remove the transport safety device from the rotor chamber and keep it in a safe place in case the centrifuge should be transported in the future.

If you have ordered a Centrifuge 5415 D including a rotor, first remove the upper transport retaining ring, open the rotor lid by pulling on the shiny button. Loosen the rotor with the provided rotor key and pull it off. If the rotor sits tightly, push the rotor edge downwards. Now remove the lower transport retaining ring from which the flagging strips hang.

1 Introduction

In order to prevent seal damage caused by false transport, the Centrifuge 5415 R may first be switched on 4 hours following installation.

Mains power and frequency must be in agreement with the information given on the device identification plate.

| | | | |
|--------------------------------|------------|-------|---------------------------|
| Fuse protection in the device: | 5415 D / R | 230 V | 2.5 A time-lag |
| | 5415 D | 120 V | 5.0 A time-lag (UL fuse) |
| | 5415 R | 120 V | 6,25 A time-lag (UL fuse) |

Now connect the centrifuge to the power source and switch it on on the right side. Insert the rotor and screw it tight with the rotor key.

The centrifuge is ready to operate when the digits appear in the display field.

Please don't move the centrifuge while the rotor is running.

Check that the rotor is sitting correctly prior to the first start.

2 Safety precautions and applicational limitations



For your own personal safety, please observe the following safety precautions:

The rotor and the rotor lid must always be correctly fastened. Centrifugation may only be carried out with a tightly fastened rotor.

Before each centrifugation operation, it is important to check whether the rotor has been tightened up to specification. To do this, place the rotor key supplied on the rotor nut and turn it clockwise until the rotor nut is firmly tightened up. Then push the polypropylene rotor lid with the seal onto the rotor nut or screw the aluminum rotor lid on tightly.

The rotor must be loaded symmetrically. Opposing tubes should be of the same type and should be filled equally.

Rotors with significant traces of corrosion or indications of mechanical damage may not be used. Please inspect the accessories regularly.

Rotors are high-quality components that must be able to withstand extreme mechanical strain. Aluminium rotors are protected against corrosion caused by commonly-used laboratory chemicals by means of an electrolytic coating, although this protection cannot be fully guaranteed.

Please ensure that the rotor is protected from mechanical damage. Even slight scratches and cracks can cause severe material damage to the rotor interior. Avoid damage caused by aggressive chemicals, including concentrated and mild alkalis, concentrated acids, solutions containing mercury ions, copper ions and other heavy-metal ions, chlorinated hydrocarbons, concentrated saline solutions and phenol. In the event of contamination caused by aggressive agents, the rotor must be cleaned immediately with a neutral detergent.

Rotors, caps or buckets having suffered chemical or mechanical damage or which have exceeded their maximum useful life may no longer be used!

Centrifuges must be correctly installed and used. Repairs may be performed only by an Eppendorf authorized service technician. Only original rotors and spare parts from Eppendorf may be used.

When transferring from a **cold room** to a normal laboratory, the Centrifuge must either be run warm for 30 minutes in the cold room or it must be allowed to warm up for at least three hours in the laboratory before connecting it to the power source to prevent damage caused by condensation.

When handling toxic or radioactive liquids or pathogenic bacteria belonging to Risk Group II (see World Health Organisation: "Laboratory Biosafety Manual"), observe national regulations. If such liquids are spilled in the rotor or the rotor chamber, the centrifuge must be cleaned thoroughly and properly. Before using cleaning and disinfecting methods other than those specified in Chapter 4 "Maintenance and cleaning", please check with the manufacturer that these methods do not damage the centrifuge.

Before centrifugation, all the tubes should be subjected to a visual inspection for material damage. Damaged tubes must not be centrifuged, as if tubes break, there may be further damage to the centrifuge and its accessories in addition to loss of the sample.

A liquid density of 1.2 g/ml must not be exceeded at the maximum rotational speed.

2 Safety precautions and applicational limitations

Sample tubes heat up over longer run times. Observe the limiting data regarding the load-bearing capacity of the centrifuge, as specified by the manufacturer.

The use of organic solvents (e.g. chloroform, phenol) may have an adverse effect on the stability of plastic test tubes.

Close the tube lids properly when centrifuging. Open tube lids can be torn off during centrifugation and damage the centrifuge.

When closing the centrifuge lid be sure that your fingers are not beneath the lid. They may otherwise become stuck.



3 Operation

3.1 Control elements

See the front view of the device, found on the fold-out page at the front of this manual:

- **TIME** - Turn time-selection dial
 - **START/STOP** - Press time-selection dial
 - **TEMP** - Temperature-selection keys (only 5415 R)
 - **SHORT** - Short-spin key
 - **FAST TEMP** - Preliminary cooling run key (only 5415 R)
 - **SPEED** - Turn speed-selection dial
 - **RPM/RCF** - Press speed-selection dial
 - **OPEN** - To open the lid (only 5415 R)
 - Rotor with 24 or 36 bores for microcentrifuge tubes
 - Rotor lid with central fastening button
 - Mains power switch (right-hand side)
 - Mains power socket with fuse element (5415 D rear, 5415 R right-hand side)
 - Identification plate with power supply values (rear)
- E** Emergency lid release, for 5415 D on the base of device, with cord; for 5415 R with rotor key from right.

3.2 Loading the rotor

The micro test tubes with a nominal volume of up to 2.0 ml are loaded into the bores of the rotor. The test tubes are positioned in pairs opposite each other and should each contain roughly the same amount of sample.

The specifications for the maximum permitted weight per bore apply to the adapter + test tube + contents.

In order to minimize air friction and noise, the rotor should not be operated without the rotor lid.



The lid must be replaced where there are visible indications of change or damage to the lid.

3 Operation

3.3 Centrifugation with time setting

Switch on the power supply. The nominal values from the last run appear in the display. Load the rotor **symmetrically**. Attach the rotor lid and close the lid of the centrifuge.

| | |
|--------------|---|
| TEMP | To set temperature preselection (only 5415 R) |
| TIME | To modify the run time. |
| SPEED | To modify the speed in increments of 200 rpm or in rcf. |
| START | To start the run. The  symbol flashes when the rotor is running. |
| STOP | To abort the run. |

The remaining time appears in the display during the run.

When the time is changed during a run, the time which has already elapsed is taken into account.

The last minute is counted down in seconds.

After the set time has expired, the centrifuge stops automatically. If the time is modified during the braking phase, the centrifuge accelerates to the nominal rotational speed.

3.4 Changing the centrifugation parameters during the run

5415 R:

Time setting, rotational speed and temperature can first be changed during the run after pressing the SHORT key, in order to prevent unintentional adjustment of the parameters during the run. To do this, briefly press the SHORT key until the display begins to blink. You can set the new centrifugation parameters using the TIME and SPEED dials and the TEMP keys. The new centrifugation parameters are adopted after 5 seconds.

5415 D:

Time setting, rotational speed and temperature can be changed during the run using the dials. The new nominal rotational speed is adopted 2 seconds after the change. A time change during the braking phase results in renewed acceleration toward the nominal rotational speed.

3.5 Fixed setting of the parameters (only for 5415 R)

In order to also secure the centrifugation parameters against unintentional adjustment during the rest period, it is possible with the Centrifuge 5415 R to fix the desired parameter settings. To do this, simultaneously press the SHORT and OPEN keys for at least 5 seconds with the centrifuge lid open. After 5 seconds the dial adjustment will be deactivated and the centrifugation parameters secured against unintentional adjustment. The fixed setting of the centrifuge parameters will be represented by a pictogram  in the Centrifuge 5415 R. The set parameters can no longer be adjusted, neither during the run or in the rest period. A centrifuge run can also be started or ended using START/STOP. It is also possible to switch the signal tones and RCF switchover on and off.

In order to reactivate the dial adjustment, simultaneously press the SHORT and OPEN keys for at least 5 seconds. The pictogram  appears in the display.

3 Operation

3.6 Centrifugation with "AT set rpm" (for 5415 R only)

With the Centrifuge 5415 R it is possible to start the centrifugation time countdown when the preselected rotational speed has been achieved ("At set rpm").

Pressing the START / STOP key for more than 2 seconds while the centrifuge lid is open results in a switch to "At set rpm" mode, represented by the  pictogram.

In order to leave the "At set rpm" mode again and to start the centrifugation time countdown immediately after starting the centrifuge, press the START/STOP key again with the centrifuge lid open for more than 2 seconds until the  pictogram appears.

3.7 Short-spin centrifugation

The SHORT key activates a short-spin run at a preset rotational speed or at maximum speed for as long as the key is held down.

- SHORT**
- If the centrifuge lid is closed and you press the key for longer than 2 s, the centrifuge will switch the mode to short spin at preselected or maximum speed.
 - If the centrifuge lid is open and you press the key for longer than 2 s, the centrifuge will switch the mode from "maximum speed" to "preselected speed" and vice-versa.
- SHORT**
- If the centrifuge lid is open and you press the key briefly, the mode you have selected will be displayed
 - 13 t Short-spin centrifugation at maximum speed
 - 1 – 13 t Short-spin centrifugation at preselected speed.
 - a short-spin run which has already been interrupted can be continued by pressing this key, if the centrifuge has not yet come to a standstill. This may be done three times in total. After this, the lid must be opened.

3.8 Continuous centrifugation

- TIME** Using the keys, set the dial to above 99 min or below 0.5 min to display 00 (= ∞). The time is counted upwards in minutes.
- STOP** To end continuous operation.

3.9 Switching to the rcf display

- SPEED** If the Speed key is pressed, the rpm and rcf values appear alternately in the display.

3.10 Cooling (only for 5415 R)

Using the **TEMP** keys, it is possible to set the nominal temperature between 0 °C and + 40 °C. The nominal temperature can also be changed during the run.

When the nominal temperature that has been set has been reached, a deviation in excess of ± 3 °C will be indicated by a flashing temperature display.

3 Operation

If the temperature deviates by more than 5 °C after the nominal temperature has been reached, the centrifuge switches off and "err 18" appears in the display.

Fast TEMP starts a temperature-control run at a rotor-specific speed. It enables the new, preselected temperature to be attained rapidly in the rotor. (Cooling down from room temperature to 4 °C takes max. 16 minutes.) The run can be stopped automatically or by pressing the **Stop** key.

Standby cooling: With the lid closed, the rotor chamber is cooled down to the preselected nominal temperature before or after the run, on condition that this temperature is below the ambient temperature. Likewise, Centrifuge 5415 R maintains the temperature after a run when the lid remains closed, temperature adaptation is slow. The nominal temperature appears in the display.

If the centrifuge is not used for longer than eight hours, or if the lid is not opened for this period, the refrigeration function switches off in order to protect the device. The actual temperature in the rotor chamber appears in the display. The desired temperature can be rapidly reattained via **Fast TEMP**.

Remove condensation water or ice (by thawing) from the rotor chamber at regular intervals using a soft, absorbent cloth.

Note: For problem-free operation at room temperatures below 18 °C, a warm-up time of approximately one hour is necessary.

3.11 Switching the signal tone on and off (only for 5415 R)

Press the OPEN key for longer than 2 seconds with the lid open. This switches the signal tone on or off alternately. The switched on signal tone is represented by the pictogram .

3.12 Opening the centrifuge in the case of a power failure



Unplug the device. Wait until the rotor comes to a standstill.
(This may take up to 5 minutes!)

The emergency lid release of the 5415 D is activated by pulling a cord on the base of the device:

A small white plastic button is located in the ground plate behind the front, right-hand suction foot. (see "E" on the fold-out page at the front of this manual). Pull out this button and pull the cord vertically downwards.

Emergency lid release 5415 R:

Remove the round stopper on the right-hand side of the housing. Insert the rotor key provided through the bore that has been vacated. The centrifuge lid is released by rotating to the left.

3.13 Device fuses

The fuse holder of the 5415 D is located below the mains plug.

The fuse holder of the 5415 R is located on the left of the main switch.

These holders may be pulled out backwards and the two fuses may be replaced (see Ordering information).

4 Cleaning and maintenance

4.1 Device

The outer surfaces of the centrifuge and the rotor chamber should be cleaned once a month using a warm detergent. Before doing so, disconnect the main power plug. Remove the rotor and clean separately. The rotor chamber should only be cleaned using a moist cloth. Only **neutral** agents may be used for cleaning (e.g. Extran[®] neutral, RBS[®] neutral or Teepol[®] 610 S) and disinfecting (e.g. Bacillo[®] AF, Meliseptol[®] or Perform[®]). Please ensure that no liquid enters the slit on the outlet of the motor shaft.

If condensation water collects in the rotor chamber, dry the chamber using a soft, absorbent cloth.

Switch off the centrifuge after use and leave the lid open.

4.2 Rotors

Rotors must be cleaned at regular intervals in order to prevent that centrifugation residue causes material changes. The rotor must be removed to do this. In the case of a tightly stuck rotor, push the rotor downwards on one side. Please check the rotor bores for residue and corrosion. The rotor is then inserted again and screwed tight with the supplied rotor key.

Please check the rotor and rotor bores regularly for corrosion and mechanical damage!



Centrifugation should not be carried out with damaged rotors.



4.3 Aerosol-tight rotors

In the case of the aerosol-tight rotor FA-45-24-11, the rotor lid should be replaced with signs of wear. Regular care of the sealing ring is necessary to protect the rotors.

The aerosol-tight rotor may not be stored with tightly closed lid!

4.4 Rotor sterilization

All rotors are autoclavable (121 °C, 20 min).

Aerosol-tight rotor lids should be replaced every 10 autoclaving cycles.

4.5 Glass breakage

When centrifuging glass tubes, please observe that high speeds/rcf's increase the risk of glass breakage. Please follow the manufacturer's instructions concerning the maximum speed/rcf of centrifuge tubes. In the event of glass breakage, carefully remove all splinters from the rotor, the buckets, the adapters and the rotor chamber. You may need to replace the rubber mats and adapters to prevent further damage.

Fine splinters of glass may otherwise scratch the surface of the rotors and buckets, reducing their resistance to chemicals. The air turbulences within the rotor chamber produce a very fine black powder of abraded metal. In addition to causing damage to the rotor chamber, rotor, buckets and adapters, the powder also contaminates the samples.

Check the rotor bores regularly for residues and damage.

4 Cleaning and maintenance

4.6 Return of the device

When returning centrifuges, please ensure that the devices have been fully decontaminated and do not thereby present a health risk to our Service staff.

You will find additional information and a blank of the decontamination confirmation at www.eppendorf.com. You can also enquire with your person responsible for lab safety regarding a suitable decontamination method.

Please fill out the decontamination confirmation and place it together with the device when it is to be sent back to Eppendorf.

5 Troubleshooting

| Error | Cause | Solution |
|---|---|--|
| No display. | No main power connection. | Plug in mains cable on both sides. |
| | Power failure. | Check main power fuse of device and of laboratory. |
| Lid cannot be opened. | Power failure. | Emergency lid release (see Sec. 3.12). |
| | Rotor is still running. | Wait for the rotor to come to a standstill. |
| Centrifuge shakes during acceleration. | Rotor not loaded symmetrically. | Stop centrifuge run and load rotor symmetrically. |
| | Rotor lid does not open correctly. | Stop centrifuge. Close the lid. |
| Centrifuge does not start. | Lid not closed. | Lift the lid and close it again. |
| The centrifuge does not restart in the Short-spin mode. | Safety function to prevent centrifuge from overheating. | Do not release key during short-spin centrifugation. |
| Flashing temperature display (only 5415 R). | Temperature deviation of > 3 °C from nominal value. | |
| Display LID | Lid latch not disengaged. | Close lid correctly, press Start / Stop or activate emergency lid release (see Sec. 3.12). |
| | Lid latch not engaged. | Lift up lid slightly and close it again. |
| INT | Power supply interrupted during run. | Check main plug. Repeat run. |
| OFF | Mains supply is switched off. | |
| Error 3 | Errors in rotational speed measurement system. | Leave centrifuge switched on and wait for 5 minutes. Repeat run. |
| Error 5 | Lid switch. | Wait for the centrifuge to come to a standstill and open the lid. Then close the lid and restart the centrifuge. |

5 Troubleshooting

| Error | Cause | Solution |
|----------------------------------|---|---|
| Error 6 | Drive error. | Repeat run. |
| Error 7 | Overspeed. | Check whether rotor is positioned correctly. |
| Error 8 | Rotor loose. Drive error. | Tighten rotor. |
| Error 9 – 25 | Electronics error. | Repeat run. |
| Error 18 (only 5415 R) | Temperature error. ($\Delta \geq 5 \text{ }^\circ\text{C}$). | Switch off the centrifuge. |
| Error 19 (only 5415 R) | Cooling circulation is overheated. | Make sure that the ventilation slit is not obstructed. |
| Error 24 (only 5415 R) | Error with cooling aggregate (e.g. overheating). | After long period of operation: Allow to cool. At the beginning of operation: Contact Service. |

If the solutions suggested here prove to be unsuccessful, please contact Brinkmann Service at 800-645-3050 in USA and 800-263-8715 in Canada.

6 Technical data

Centrifuge 5415 D

| | |
|---|--|
| Power supply: | 230 V / 50 – 60 Hz 120 V / 50 – 60 Hz see identification plate |
| Power requirement: | 180 W |
| Max. rotational speed: | 13,200 rpm |
| Max. centrifugal force: | 16,110 rcf |
| Max. load: | 24 x 2.0 ml Safe-Lock Micro Test Tubes or 36 x 0.5 ml tubes |
| Max. kinetic energy: | 3,100 Nm |
| Max. density of material to be centrifuged: | 1.2 g/ml |
| Ambient temperature: | 2 °C – 35 °C |
| Max. relative humidity: | 75 % |
| Dimensions: | Height: 230 mm Depth: 310 mm Width: 230 mm |
| Weight (without rotor): | 8.5 kg |
| Acceleration time (230 V): | < 13 sec. |
| Deceleration time: | < 11 sec. |
| Acceleration time (100 / 120 V): | < 15 sec. |
| Deceleration time: | < 13 sec. |

Centrifuge 5415 R

| | |
|---|--|
| Power supply: | 230 V / 50 – 60 Hz 120 V / 50 – 60 Hz see identification plate |
| Power requirement: | 300 W |
| Max. rotational speed: | 13,200 rpm |
| Max. centrifugal force: | 16,100 rcf |
| Max. load: | 24 x 2.0 ml Safe-Lock Micro Test Tubes or 36 x 0.5 ml tubes |
| Max. kinetic energy: | 3,100 Nm |
| Max. density of material to be centrifuged: | 1.2 g/ml |

6 Technical data

| | |
|----------------------------------|--|
| Ambient temperature: | 2 °C – 35 °C |
| Max. relative humidity: | 75 % |
| Dimensions: | Height: 249 mm Depth: 450 mm Width: 290 mm |
| Weight (without rotor): | 21.2 kg |
| Degree of pollution | 2 |
| Overvoltage category | II |
| Acceleration time (230 V): | < 13 sec. |
| Deceleration time: | < 11 sec. |
| Acceleration time (100 / 120 V): | < 15 sec. |
| Deceleration time: | < 13 sec. |

Technical specifications subject to change!

7 Ordering information

7

Ordering information

| | |
|---|-------------|
| Centrifuge 5415 R 120V / 50 – 60 Hz, without rotor | 22 62 140-8 |
| Centrifuge 5415 D 120 V / 50 – 60 Hz, without rotor | 22 62 121-1 |
| Standard rotor F-45-24-11 aluminum, 24 bores, max. ø 11 mm, 45° angle, for 1.5 / 2 ml microcentrifuge tubes, with polypropylene lid | 22 63 650-2 |
| Rotor FA-45-24-11 incl. aerosol-tight rotor lid | 22 63 659-6 |
| Adapter for 0.5 ml microcentrifuge tubes and 0.6 ml Microtainers, for F-45-24-11, set of 6 | 22 63 622-7 |
| Adapter for 0.4 ml microcentrifuge tubes, for F-45-24-11, set of 6 | 22 63 624-3 |
| Adapter for 0.2 ml PCR test tubes, for F-45-24-11, set of 6 | 22 63 626-0 |
| Special rotor F-45-36-8 aluminum, 36 bores, max. ø 8 mm, 45° angle, for 0.5 ml microcentrifuge tubes, with polypropylene lid | 22 63 650-2 |
| Adapter for 0.2 ml PCR test tubes, for special rotor F-45-36-8, set of 6 | 22 63 660-0 |
| Accessories | |
| Replacement lid for rotor F-45-24-11 (polypropylene) | 22 66 728-9 |
| Replacement lid for rotor FA-45-24-11 (aluminum), aerosol-tight | 22 63 675-8 |
| Replacement lid for rotor F-45-36-8 (polypropylene) | 22 66 729-7 |
| Rotor key | 22 66 718-1 |
| Fuse 230 V (2.5 A slow) | 22 66 818-8 |
| Fuse 120 V (5 A slow UL) | 22 66 822-6 |

Important:

Please use the original accessories recommended by Eppendorf. Using spare parts or disposables which we have not recommended can reduce the precision, accuracy and life of the centrifuges. We do not honor any warranty or accept any responsibility for damage resulting from such action.

For assistance or service, contact:

Eppendorf North America, Inc.
One Cantiague Road, P.O. Box 1019
Westbury, New York 11590-0207 (USA)
Phone: 800-645-3050
Fax: 516-334-7506
e-mail: info@eppendorf.com
Internet: www.eppendorfna.com

7 Ordering information

Rotor code

All Eppendorf rotors are designated according to a simple, logical system which describes the technical specifications as a uniform series of numbers and letters e.g.:

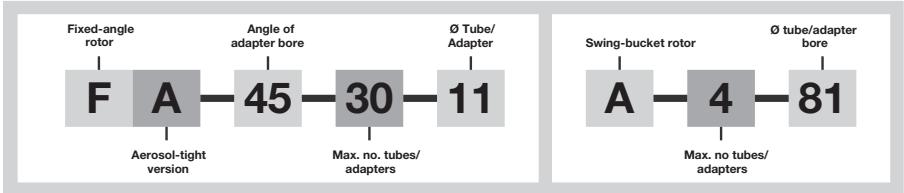

EG-Konformitätserklärung EC Conformity Declaration

Das bezeichnete Produkt entspricht den einschlägigen grundlegenden Anforderungen der aufgeführten EG-Richtlinien und Normen. Bei einer nicht mit uns abgestimmten Änderung des Produktes oder einer nicht bestimmungsgemäßen Anwendung verliert diese Erklärung ihre Gültigkeit.

The product named below fulfills the relevant fundamental requirements of the EC directives and standards listed. In the case of unauthorized modifications to the product or an unintended use this declaration becomes invalid.

Produktbezeichnung, Product name:

Centrifuge 5415 D / R

Produkttyp, Product type:

Laborzentrifuge / Laboratory Centrifuge

Einschlägige EG-Richtlinien/Normen, Relevant EC directives/standards:

73/23/EWG, EN 61010-1, EN 61010-2-20

89/336/EWG, EN 55011/B, EN 61000-6-1, EN 61000-3-2, EN 61000-3-3

98/37/EG, EN 292-2, EN 292-2/A1,

98/79/EG, EN 61326

Vorstand, Board of Management:

19.08.2003

Hamburg, Date:

Projektmanagement, Project Management:

eppendorf



Eppendorf AG · Barkhausenweg 1 · 22339 Hamburg · Germany

Eppendorf Offices

ASEAN

Eppendorf AG
Regional Office in Malaysia
Tel. +60 3 8023 2769
Fax +60 3 8023 3720
E-Mail: eppendorf@eppendorf.com.my
Internet: www.eppendorf.com.my

AUSTRALIA / NEW ZEALAND

Eppendorf South Pacific Pty. Ltd.
Tel. +61 2 9889 5000
Fax +61 2 9889 5111
E-mail: Info@eppendorf.com.au
Internet: www.eppendorf.com.au

AUSTRIA

Eppendorf AG
c/o Schott Austria
Tel. +43 1 29017560
Fax +43 1 290175620
E-Mail: gilch.p@eppendorf.de
Internet: www.eppendorf.com

BRAZIL

Eppendorf do Brasil Ltda.
Tel. +55 11 30 95 93 44
Fax +55 11 30 95 93 40
E-Mail: eppendorf@eppendorf.com.br
Internet: www.eppendorf.com.br

CANADA

Brinkmann Instruments, Ltd.
Tel. +1 905 826 5525
Fax +1 905 826 5424
E-Mail: canada@brinkmann.com
Internet: www.brinkmann.com

CHINA

Eppendorf AG
Tel. +86 21 68760880
Fax +86 21 50815371
E-Mail: market.info@eppendorf.cn
Internet: www.eppendorf.cn

FRANCE

EPPENDORF FRANCE S.A.R.L.
Tel. +33 1 30 15 67 40
Fax +33 1 30 15 67 45
E-Mail: eppendorf@eppendorf.fr
Internet: www.eppendorf.fr

GERMANY

Eppendorf Vertrieb
Deutschland GmbH
Tel. +49 02232 418-0
Fax +49 02232 418-155
E-Mail: vertrieb@eppendorf.de
Internet: www.eppendorf.de

INDIA

Eppendorf India Limited
Tel. +91 44 52111314
Fax +91 44 52187405
E-Mail: info@eppendorf.co.in
Internet: www.eppendorf.co.in

ITALY

Eppendorf s.r.l.
Tel. +390 2 55 404 1
Fax +390 2 58 013 438
E-Mail: eppendorf@eppendorf.it
Internet: www.eppendorf.it

JAPAN

Eppendorf Japan Co. Ltd.
Tel. +81 3 5825 2363
Fax +81 3 5825 2365
E-Mail: info@eppendorf.jp
Internet: www.eppendorf.jp

NORDIC

Eppendorf Nordic Aps
Tel. +45 70 22 2970
Fax +45 45 76 7370
E-Mail: nordic@eppendorf.dk
Internet: www.eppendorf.dk

SPAIN

Eppendorf Ibérica S.L.
Tel. +34 91 651 76 94
Fax +34 91 651 81 44
E-Mail: iberica@eppendorf.de
Internet: www.eppendorf.es

SWITZERLAND

Vaudaux-Eppendorf AG
Tel. +41 61 482 1414
Fax +41 61 482 1419
E-Mail: vaudaux@vaudaux.ch
Internet: www.eppendorf.com

UNITED KINGDOM

Eppendorf UK Limited
Tel. +44 1223 200 440
Fax +44 1223 200 441
E-Mail: sales@eppendorf.co.uk
Internet: www.eppendorf.co.uk

USA

Eppendorf North America
Tel. +1 516 334 7500
Fax +1 516 334 7506
E-Mail: info@eppendorf.com
Internet: www.eppendorfna.com

OTHER COUNTRIES

see:
www.eppendorf.com/worldwide

eppendorf

In touch with life

Your local distributor: www.eppendorf.com/worldwide

Eppendorf AG · 22331 Hamburg · Germany · Tel. +49 40 5 38 01-0 · Fax +49 40 5 38 01-556
E-Mail: eppendorf@eppendorf.com

Eppendorf North America, Inc. · One Cantiague Road, P.O. Box 1019 · Westbury, N.Y. 11590-0207 USA
Tel. +1 516 3 34 75 00 · Free phone +1 800 6 45 30 50 · Fax +1 516 3 34 75 06 · E-Mail: info@eppendorf.com

Application Support

Europe, International: Tel. +49 180 3 66 67 89 · E-Mail: support@eppendorf.com
North America: Tel. +1 800 6 45 30 50 ext. 2258 · E-Mail: support_NA@eppendorf.com
Asia, Pacific: Tel. +60 3 80 23 27 69 · E-Mail: support_Asia@eppendorf.com